

Errata

Title & Document Type: 1652B/1653B Logic Analyzer Getting Started Guide

Manual Part Number: 5952-0176

Revision Date: January 1990

HP References in this Manual

This manual may contain references to HP or Hewlett-Packard. Please note that Hewlett-Packard's former test and measurement, semiconductor products and chemical analysis businesses are now part of Agilent Technologies. We have made no changes to this manual copy. The HP XXXX referred to in this document is now the Agilent XXXX. For example, model number HP8648A is now model number Agilent 8648A.

About this Manual

We've added this manual to the Agilent website in an effort to help you support your product. This manual provides the best information we could find. It may be incomplete or contain dated information, and the scan quality may not be ideal. If we find a better copy in the future, we will add it to the Agilent website.

Support for Your Product

Agilent no longer sells or supports this product. You will find any other available product information on the Agilent Test & Measurement website:

www.tm.agilent.com

Search for the model number of this product, and the resulting product page will guide you to any available information. Our service centers may be able to perform calibration if no repair parts are needed, but no other support from Agilent is available.

Getting Started Guide

**HP 1652B/HP 1653B
Logic Analyzers**



©Copyright Hewlett-Packard Company 1990

Manual Set Part Number 5952-0176

Printed in the U.S.A. January 1990

Introduction

About this book...

Welcome to Hewlett-Packard logic analyzers. The HP 1652B and HP 1653B Logic Analyzers are more than just another logic analyzer. They are an analyzer and oscilloscope in one instrument. With this combination, you have expanded measurement capabilities.

The user interface of the HP 1652B/HP 1653B was designed to be as easy to operate as possible. The use of "pop up" windows help lead you through setups and measurements without having to memorize a lot of steps. As you read this guide and the other references about the logic analyzer, you will see just how easy to use the HP 1652B/HP 1653B really is.

We will not cover every feature and function of the HP 1652B/HP 1653B Logic Analyzer in this guide. The purpose of this *Getting Started Guide*, is to get you going quickly, by giving you the basic user interface information along with a couple measurement examples. The detailed information will be found in the *HP 1652B/HP 1653B Front-Panel Operation Reference*.

If you are new to logic analyzers and digitizing oscilloscopes, or just need a refresher, we think you will find *Feeling Comfortable With Logic Analyzers* and *Feeling Comfortable With Digitizing Oscilloscopes* valuable reading. These books will help eliminate any misconceptions or confusion you may have about the analyzer's applications, and will show you how to get the most out of its measurement functions.

How to use this guide

This guide is organized into two types of information. The first three chapters cover basic user interface information. If you are an experienced HP logic analyzer user, but new to this family of logic analyzers, you may want to read just the first three chapters and then go directly to the *HP 1652B/HP 1653B Front-Panel Operation Reference*.

The next three chapters simulate basic measurements in a task-oriented format. These example measurements, illustrate menu setup, in a step by step order commonly followed when solving digital system problems. If you are new to HP logic analyzers and logic analysis, you should include the measurement examples as part of your reading.

You will see illustrations of menu setups interspersed with text. If you are going through a sequence for the first time, you should refer to the illustrations while reading the text, to aid your understanding. If you are a fast learner and remember the first three chapters on the user interface, you can follow through the examples by just referring to the illustrations.

Contents

Chapter 1:

Introducing the HP1652B/HP 1653B

What Are the HP 1652B and HP 1653B?	1-1
Getting Ready to Operate	1-2
Initial Inspection ..	1-2
Accessories	1-3
Removing Yellow Shipping Disk	1-3
Selecting the Line Voltage	1-4
Checking for the Correct Fuse	1-5
Connecting the Power Cable	1-5
Operating Environment and Ventilation	1-6
Loading the Operating System	1-6
Installing the Operating System Disk	1-7
Line Switch ..	1-8
Power-up Self-Test	1-9
Adjusting the Display Intensity	1-10
Summary ..	1-10

Chapter 2:

Getting to Know the Front Panel

Introduction	2-1
Front Panel Organization	2-1
Display	2-2
Cursor ..	2-2
Menu Keys	2-2
Disk Drive	2-3
Roll Keys ..	2-3
Knob	2-3
Inputs	2-3
Keypad	2-4
Summary ..	2-4

<hr/>	
Chapter 3:	Gettin to Know the Main Menus
	Introduction 3-1
	Exploring the System Configuration Menu 3-1
	Using the Cursor, Knob and SELECT Key 3-2
	Configuring the Analyzer 3-2
	Pod Assignments 3-3
	Autoscale 3-4
	Moving Around the Main Menus 3-5
	Accessing the Main Menus 3-5
	TRACE/TRIG 3-6
	DISPLAY 3-6
	Returning to the System Configuration Menu 3-7
	Summary 3-8
<hr/>	
Chapter 4:	Using the State Analyzer
	Introduction 4-1
	Problem Solving with the State Analyzer 4-2
	What Am I Going to Measure? 4-2
	How Do I Configure the Logic Analyzer? 4-4
	Connecting the Probes 4-6
	Activity Indicators 4-6
	Configuring the State Analyzer 4-7
	Specifying the J Clock 4-9
	Specifying a Trigger Condition 4-10
	Acquiring the Data 4-12
	The State Listing 4-13
	Finding the Answer 4-14
	Summary 4-16
<hr/>	
Chapter 5:	Using the Timing Analyzer
	Introduction 5-1
	Problem Solving with the Timing Analyzer 5-2
	What Am I Going to Measure? 5-2
	How Do I Configure the Logic Analyzer? 5-3
	Connecting the Probes 5-5
	Activity Indicators 5-5
	Configuring the Timing Analyzer 5-6

Specifying a Trigger Condition	5-8
Acquiring the Data	5-9
The Timing Waveforms Menu	5-10
The X and O	5-10
The ▼	5-11
The Vertical Dotted Line	5-11
Configuring the Display	5-12
Display Resolution	5-12
Making the Measurement	5-13
Finding the Answer	5-14
Summary	5-15

Chapter 6:	Using the Oscilloscope
Introduction	6-1
Getting to the Scope Menus	6-1
Setting Up for the Measurement	6-2
Making the Measurement	6-3
Displaying the Results	6-4
Automatic Measurement Readouts	6-5
Using the Markers	6-5
Summary	6-7

Chapter 7:	What's Next?
-------------------	---------------------

Appendix A:	Logic Analyzer Turn-on Check List
--------------------	--

Appendix B:	Making Hardcopy Prints
Introduction	B-1
Hooking Up Your Printer	B-1
Setting RS-232C for HP Printers	B-2
Setting RS-232C for Your Non-HP Printer	B-3
Setting Hp_IB for HP Printers	B-4
Starting the Printout	B-5
Print Screen	B-5
Print All	B-6
What Happens during a Printout?	B-6
Summary	B-6

Introducing the HP1652B/HP 1653B

What Are the HP 1652B and HP 1653B?

The HP 1652B and HP 1653B logic analyzers are general-purpose logic analyzers with built-in oscilloscopes. If you're familiar with the HP 1652B/HP 1653B or any HP digitizing oscilloscope, you'll recognize many features that you've grown to know and love. If you're new to our analyzers and oscilloscopes, the HP 1652B/HP 1653B is easy to get to know.

The only differences between the HP 1653B and the HP 1652B, are the number of data channels and the speed of the state analyzer. The HP 1652B has 80 data channels and 35 MHz state analysis while the HP 1653B has 32 data channels and 25 MHz state analysis. Both analyzers have 100 MHz timing analysis along with 100 MHz single-shot and repetitive (repetitive single-shot) oscilloscope measurement capabilities. Because the differences are small between both instruments, they use the same set of manuals.

Some of the key features shared by both the HP 1652B and HP 1653B are listed below:

- Transitional or glitch timing mode on all channels.
- Simultaneous state/state or state/timing modes.
- Glitch detection on all channels.
- Marker measurements.
- Timing and Scope Autoscale
- Scope Automeasure.
- Pattern, edge, and glitch triggering.
- Overlapping of waveforms.
- Small lightweight probing.
- Time and number of states tagging
- State Compare, Waveform, and Chart.

This *Getting Started Guide* covers only a few of the logic analyzer's features. You will find details of all the features of the HP 1652B and HP 1653B in the *HP 1652B/HP 1653B Front-Panel Operation Reference Manual*.

Getting Ready to Operate

If you have just unpacked your new HP 1652B/1653B logic analyzer, please take a few minutes to completely read this chapter. It tells you how to prepare your logic analyzer for applying power and turning it on. If you are learning how to use the logic analyzer and it is already turned on, start with chapter 2, "Getting to Know the Front Panel".

Initial Inspection

Inspect the shipping container for damage. If the shipping container or packaging materials are damaged, you should keep them until the contents of the shipment have been checked for completeness and the instrument has been checked mechanically and electrically.

If there is damage to the instrument, refer to the service manual for the proper procedure for contacting the nearest service center.

Accessories

In addition to checking the instrument for damage, you should also check to see that the accessories supplied with it are complete.

The *HP 1652B/HP 1653B Front-Panel Operation Reference Manual* lists all the accessories shipped with the HP 1652B/HP1653B logic analyzers. If any of these items are missing contact your nearest Hewlett-Packard Sales Office.

Removing Yellow Shipping Disk

Your logic analyzer is shipped with a protective yellow shipping disk in the disk drive. Before you can insert the operating system disk you must remove the yellow shipping disk.

Slide the white locking tab to the right and press the disk ejection button as shown in the following figure. The yellow shipping disk will pop out part way so you can pull it out of the disk drive.

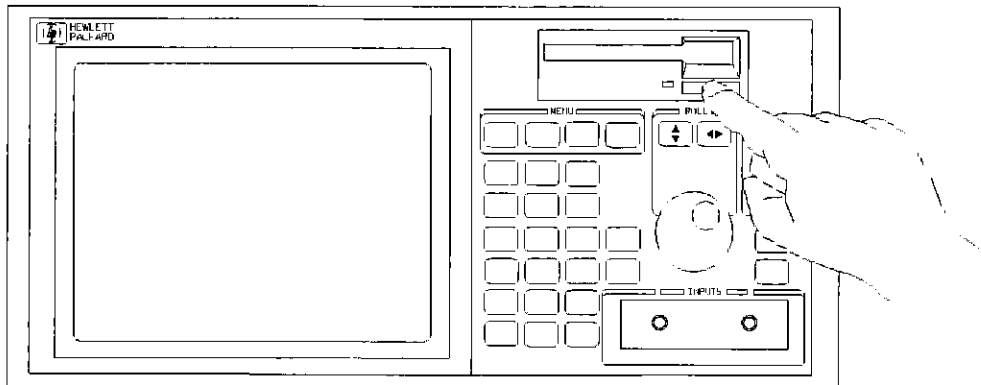

01652E06

Selecting the Line Voltage

The line voltage selector has been set at the factory to the line voltage used in your country. It is a good idea to check the setting of the line voltage selector so you can become familiar with what it looks like. If the setting needs to be changed, follow the procedure in the next paragraph.

Caution

You can damage the logic analyzer if the fuse module is not set to the correct position.

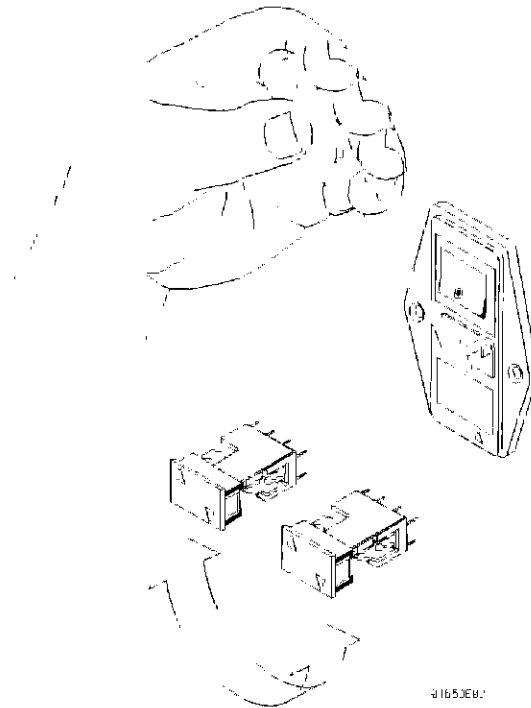

You change the line voltage setting by pulling the fuse module out and re-inserting it with the proper arrows aligned. To remove the fuse module, carefully pry at the top center of the module, as shown in the figure above, until you can grasp it and pull it out by hand.

Checking for the Correct Fuse

If you need to check for the correct fuses, remove the fuse module and look at the amperage and voltage of each fuse. The following figure will help you locate the 115 V and 230 V fuses. To remove the fuse module, carefully pry at the top center of the module until you can grasp it and pull it out by hand. (Refer to, "Selecting the Line Voltage" on the previous page.)

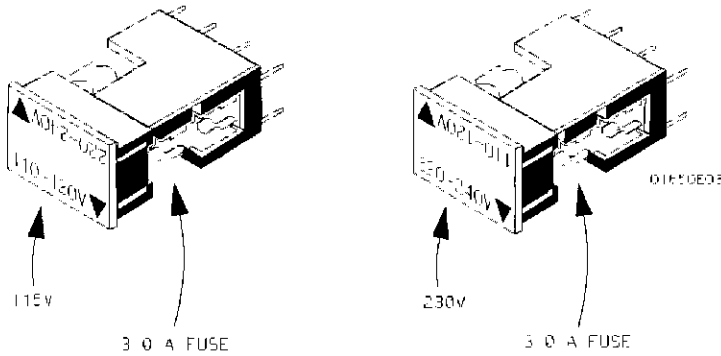

Connecting the Power Cable

The HP 1652B/HP 1653B comes with a 3-wire power cable. When you connect the cable to an appropriate AC power receptacle, a ground is provided for the instrument cabinet. The type of power cable you receive with the instrument depends on your country. Refer to appendix D of the *HP 1652B/HP 1653B Front-Panel Operation Reference* manual for power cord types.



To avoid possible shock hazard, you must connect the instrument to a properly grounded 3-wire receptacle.

Operating Environment and Ventilation

You may operate your logic analyzer in a normal lab or office environment, but don't block its ventilation. You must provide an unrestricted airflow for the fan and ventilation openings in the rear of the logic analyzer. However, you may stack the logic analyzer under, over, or in-between other instruments as long as the surfaces of the other instruments aren't needed for their ventilation. If you intend to use it in another type of environment, refer to Appendix F in the *HP 1652B/HP 1653B Front-Panel Operation Reference Manual*.

Loading the Operating System

Before you can operate the logic analyzer, it must transfer its operating system from disk memory to its internal memory. This is called "loading the operating system" or "booting."

The logic analyzer operating system is a set of instructions that control the operation of the instrument. The operating system resides on a 3.5-inch flexible disk. You received two identical operating system disks. You should mark one of them **Master** and store it in a safe place. Mark the other one **Work** and use only the work copy. This will provide you with a back-up in case your work copy becomes corrupt.

Caution

To prevent damage to your operating system disk, **DO NOT** remove the disk from the disk drive while it is running. Remove it only after the indicator light has gone out.

Installing the Operating System Disk

To load the logic analyzer's operating system, you must install the disk as shown below **before** you turn on the power. When the disk snaps into place, the disk eject button will pop out.

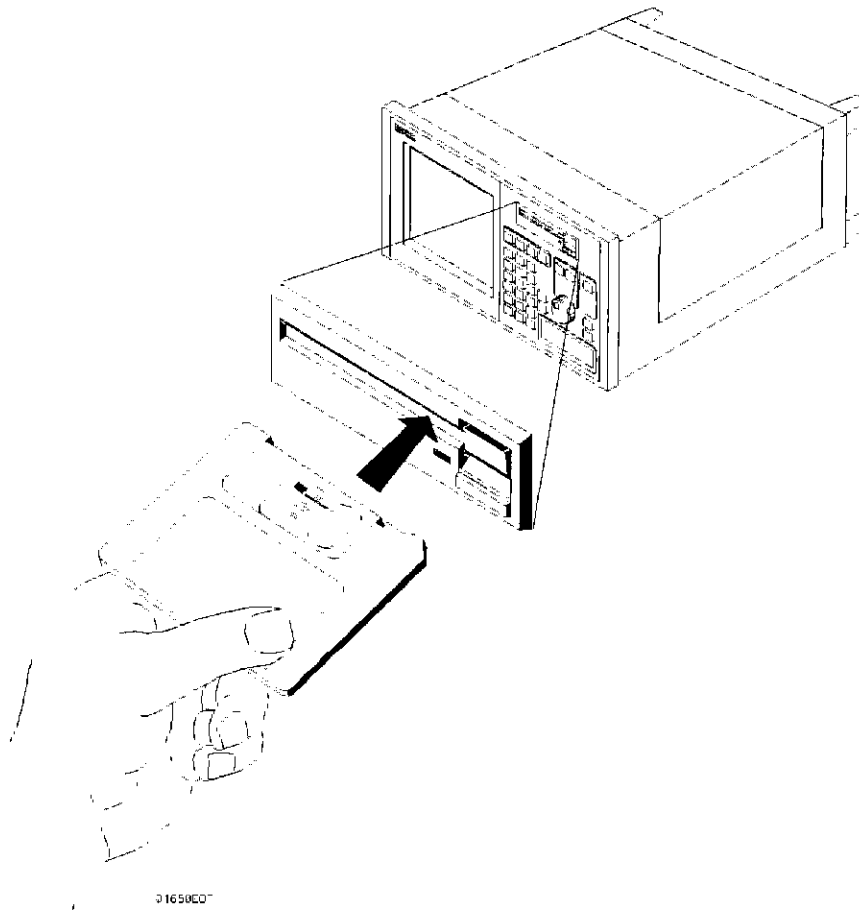

Line Switch

The line switch is on the rear panel. You turn on the logic analyzer by pressing the "1" on the rocker switch. Make sure the operating system disk is in the disk drive before you turn it on. If you forget the disk, don't worry, you won't harm anything. You will merely have to repeat the turn-on procedure with the disk in the drive.

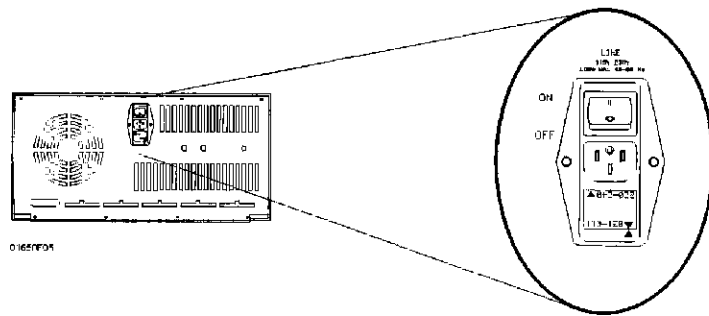

Power-up Self-Test

When you turn on the logic analyzer, it performs a series of self-tests. When it has successfully completed these tests, it loads the operating system into memory from the disk.

When the logic analyzer has completely loaded the operating system it displays the System Configuration menu as shown below.

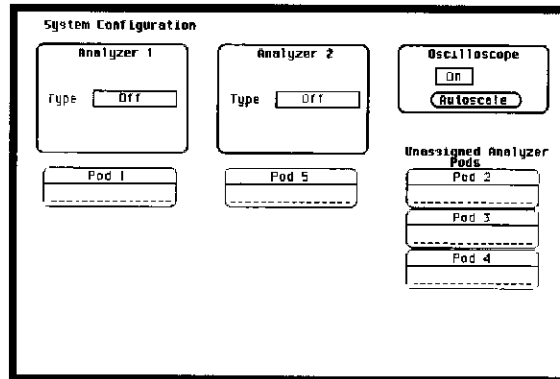

Note

This is the HP 1652B System Configuration menu. If you have an HP 1653B, the only difference is pod 1 will be assigned to analyzer 1 and pod 2 will be assigned to analyzer 2. There won't be any pods in the **Unassigned** area of the display.

Adjusting the Display Intensity

Once you have turned on the instrument, you may want to set the display intensity to a different level that's more comfortable for you. You do this by turning the INTENSITY control on the rear panel.

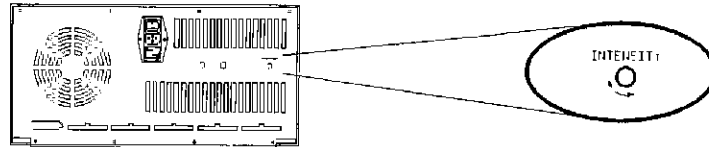

01650EDF

Note

A high intensity level setting may shorten the life of the CRT in your instrument.

Summary

Now that you have unpacked, inspected, and begun operating the logic analyzer, the next step will depend on your needs. If you are a first-time logic analyzer user who wanted to get the instrument running before reading *Feeling Comfortable with Logic Analyzers* and *Feeling Comfortable with Digitizing Oscilloscopes*, you should read them now. If you are familiar with logic analysis, read either the rest of this *Getting Started Guide* or the *HP 1652B/HP 1653B Front-Panel Operation Reference Manual*.

Getting to Know the Front Panel

Introduction

The HP 1652B/HP 1653B logic analyzers have been designed to be very easy to use. The controls are located logically by function so you can learn how to use them quickly and easily.

This chapter divides the front panel into these functional areas and gives you an overview of each area.

Front Panel Organization

The functional areas of the front panel are the display, disk drive, menu keys, roll keys, cursor, keypad, knob and input.

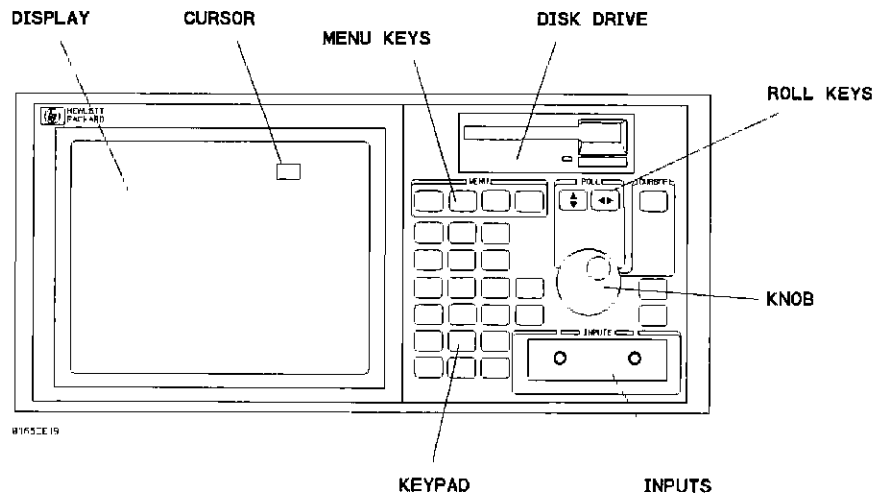

Display The display is where the various menu screens appear. Menu screens show analyzer and oscilloscope configurations as well as measurement results. Menus have many different functions you can execute. Most functions are activated by highlighting a field in the menu with the cursor, and then pressing the SELECT key.

Cursor The cursor is a movable indicator on the display that allows you to access desired fields in each menu. It changes the field where it resides from the normal white background to the dark background (inverse video). The knob moves the cursor to the field (function) you wish to activate.

Menu Keys The MENU keys allow you to quickly move between the major menus that are available. What menus are available depends on which part of the HP 1652B or HP 1653B you are currently using.

When the **FORMAT/CHAN** key is pressed, the following menus appear:

- State Format Specification (if you are in the state analyzer)
- Timing Format Specification (if you are in the timing analyzer)
- Channel (if you are in the oscilloscope)

When the **TRACE/TRIG** key is pressed, the following menus appear:

- State Trace Specification (if you are in the state analyzer)
- Timing Trace Specification (if you are in the timing analyzer)
- Trigger (if you are in the oscilloscope)

When the **DISPLAY** key is pressed, the following menus appear:

- State Listing (if you are in the state analyzer)
- Timing Waveforms (if you are in the timing analyzer)
- Waveforms (if you are in the oscilloscope)

When the **I/O** key is pressed, the same menu appears no matter which part of the HP 1652B or HP 1653B you are using. The I/O menu makes available all the Input /Output operations.

Disk Drive The disk drive is used by the HP 1652B/HP 1653B to load the operating system every time the logic analyzer is turned on. You will use the disk drive to load configurations or store configurations, acquired data, and inverse assemblers for later use. The disk drive uses 3.5-inch flexible disks. More information on loading files is found in Appendix B of this guide. Complete details on the disk drive and its functions can be found in the *HP 1652B/HP 1653B Front-Panel Operation Reference* manual.

Roll Keys When part of the listing or waveforms data is off screen, the ROLL keys define which way the knob will move the displayed data. You will use these keys and the knob to roll displayed data up/down or left/right to view data that is off-screen.

Knob The Knob has four major functions depending on what menu or pop-up menu you are in. The KNOB allows you to do the following actions:

- Move the cursor from field to field within the System Configuration and main menus.
- Roll the display left or right and up or down.
- Position the cursor on options within pop-up menus.
- Increment/decrement numeric values in numeric entry pop-ups.

Inputs The HP 1652B and HP 1653B has both front-panel inputs and rear panel inputs/outputs. The front panel INPUTS 1 and 2 are for signal input to the oscilloscope. BNC cables or oscilloscope probes can be used.

Logic analyzer probe inputs, labeled by POD and CLOCK, are located on the rear-panel. In addition, a Probe Compensation Signal, and EXTERNAL TRIGGER IN/OUT BNCs are on the rear-panel.

Keypad The keypad has keys for entering data as well as the **RUN** and **STOP** keys (for acquiring waveform data). When entering numeric data, use the **CHS** key to change the sign of the number. When entering patterns, the **DON'T CARE** key enters an X ("don't care") in place of a regular digit. Pressing **CLEAR ENTRY** replaces the entry with the default value.

Summary

Now that you are acquainted with the front panel organization, you will be able to decide where you want to go next. If you are just starting to learn logic analysis, you should read this entire guide. If you are experienced in logic analysis, you should continue to read chapter 3 to become more familiar with the operation of the front panel before you turn to the reference manual.

Getting to Know the Main Menus

Introduction

This chapter introduces you to the main menus of the HP 1652B and HP 1653B. The main menus are used to configure the logic analyzer and display the measurement results. In this chapter, you will learn how to move between the different machines (state analyzer, timing analyzer, and oscilloscope) and how to move between menus within each machine. You will also learn how to quickly get back to the System Configuration menu from any of the main menus.

In addition to learning the main menus, you will be introduced to some common pop-up menu types. There is more information on the use of all the pop-up types in the example exercises in chapters 4 through 6.

Exploring the System Configuration Menu

The first exercise in this chapter starts from the System Configuration menu. If you are not in the System Configuration menu as shown below, turn the power switch off, then back on.

An HP 1652B is used in this example. If you have an HP 1653B, there will only be two pods. The following procedure is the same for both logic analyzers.

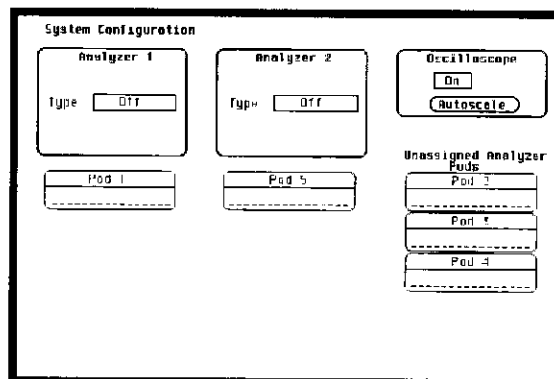

Using the Cursor, Knob and SELECT Key

Most of the logic analyzer operation is initiated by placing the **cursor** on the field you want to interact with and pressing the **SELECT** key. To move the cursor from field to field, just turn the **knob**.

Depending on the field type (immediate execute or pop-up) pressing **SELECT** will either execute a function or open a pop-up menu.

Configuring the Analyzer

In the following exercise, you will use a selector type pop-up to assign Analyzer 1 as a state analyzer and Analyzer 2 as a timing analyzer. You will use the Alpha Entry pop-up to assign unique names to each analyzer.

1. Select the **Type:** field of Analyzer 1, then select **State** from the selector pop-up.

Notice, once you have assigned Analyzer 1 as State, a new field appears directly above the **Type:** field. This new **Name:** field, is where you will assign the analyzer's unique label.

2. Select the **Name:** field. An Alpha Entry pop-up will appear.
3. Use the knob to place the cursor over the letter you want, then press the **SELECT** key. As you repeat this step for all the letters in the label, the label will be spelled out, left to right, inside the bracket at the bottom of the pop-up.

To make changes or corrections in the Alpha Entry field, place the under-score marker under the character you want to change.

To move the under-score marker to the left, place the cursor over the left arrow and press **SELECT** once for each backspace.

To move the under-score marker to the right, you either place the cursor on a desired character and press **SELECT**, or place it on the right arrow and press **SELECT**.

You can also use the **ROLL** keys and the **knob** to move the underscore marker.

4. When you are finished spelling out the label, select **Done**.
5. Repeat steps 1 through 5, assigning Analyzer 2 as **Timing**.

The figure below is what your System Configuration menu should look like. For this example, we have labeled Analyzers 1 "MY STATE" and Analyzer 2 "MY TIMING."

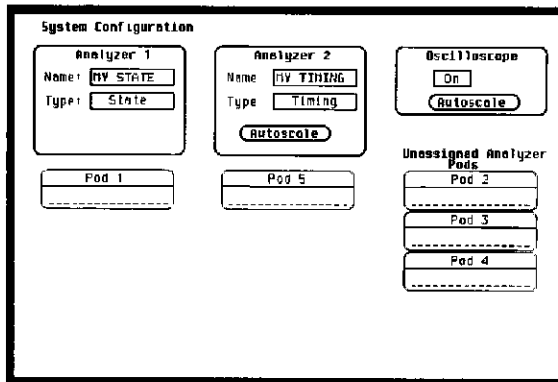

Pod Assignments Pod labels in the System Configuration menu match the inputs on the rear panel. Pods are assigned to the analyzer machines as follows.

1. Position the cursor over the **Pod** you want to assign, as shown below, then press the **SELECT** key.
2. When the selection pop-up appears, select the **Analyzer** you want the pod assigned to. The pod will automatically move under the analyzer machine you select.

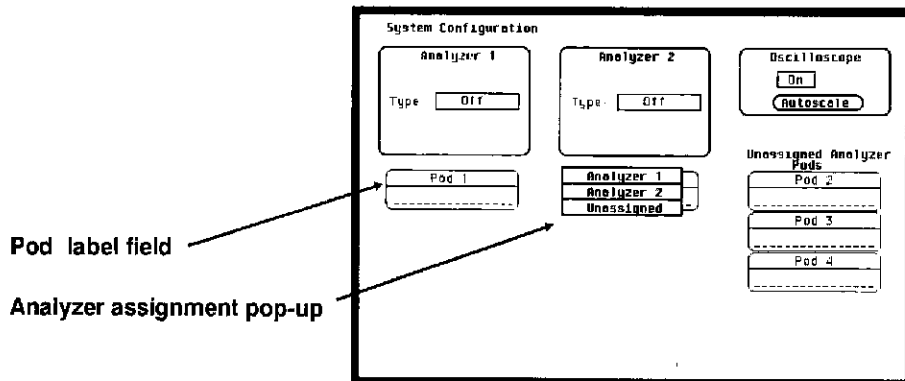

Autoscale The System Configuration menu has two Autoscale fields. One is for the timing analyzer, and one is for the scope. If you select either **Autoscale** from the System Configuration menu, the logic analyzer will display a pop-up with the choices of **Cancel** and **Continue**. The **Cancel** allows you to change your mind before the autoscale is executed.

Note 

When Autoscale is executed, instrument settings for any previous measurement will change. The new measurement will automatically be scaled for the best display of the waveform.

If you select **Continue**, the logic analyzer will display the Waveform menu of either the timing analyzer or the scope. The Waveforms display that is returned, depends on which Autoscale field you selected.

If there is no signal activity at the probe inputs, the Waveforms menu will not display data and the label to the left of the waveform area will be **-off-**. The figure below shows the waveforms menu for the timing analyzer after Autoscale was selected.

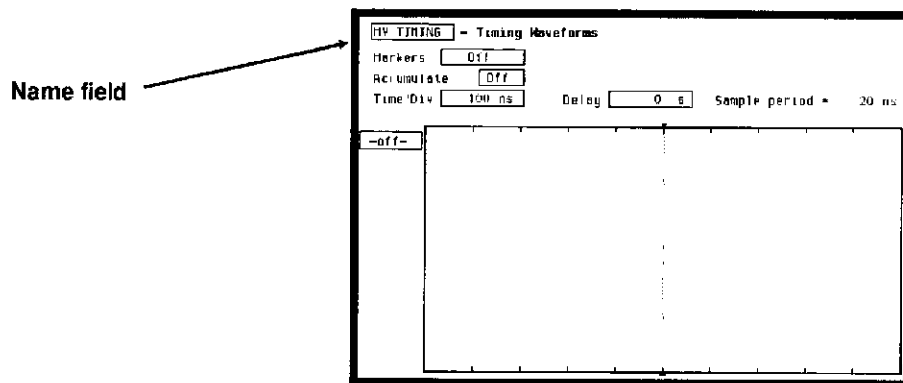

After an Autoscale, you can get back to the System Configuration menu by following the steps below.

1. Place the cursor on the **Name:** field in the upper left corner and press **SELECT**.
2. Place the cursor on the **System** field in the pop-up and press **SELECT**. You will now be back in the System Configuration menu.

Moving Around the Main Menus

The two logic analyzer types and the oscilloscope each have their own set of menus. You can enter these menus and move between them by pressing the **FORMAT/CHAN**, **TRACE/TRIG** and **DISPLAY** menu keys. These keys, as shown below, are in the area labeled **MENU**.



A fourth menu key labeled **I/O**, will bring up a pop-up menu that is independent of the analyzer and oscilloscope settings. The **I/O** functions available in this pop-up will be explained in detail in the *HP 1652B/HP 1653B Front-Panel Operation Reference* manual.

Accessing the Main Menus

When you turn Analyzer 1, Analyzer 2, or Oscilloscope on from the System Configuration menu, you also assign their set of main menus to the **MENU** keys.

In the following exercise, you will access the Format Specification menus of both analyzer machines and the Channel menu of the oscilloscope.

1. Press the **FORMAT/CHAN** key. One of the following main menus will appear:
 - Scope Channel menu (if the scope is on).
 - State Format Specification menu (if the state analyzer is on).
 - Timing Format Specification menu (if the timing analyzer is on).

If, for example, the State Format Specification menu appears, but you wanted a **FORMAT/CHAN** menu of a different machine, continue with step 2.

2. Using the **Knob**, move the cursor to the analyzer **Name:** field (upper left corner) and press the **SELECT** key. See the figure on the following page.

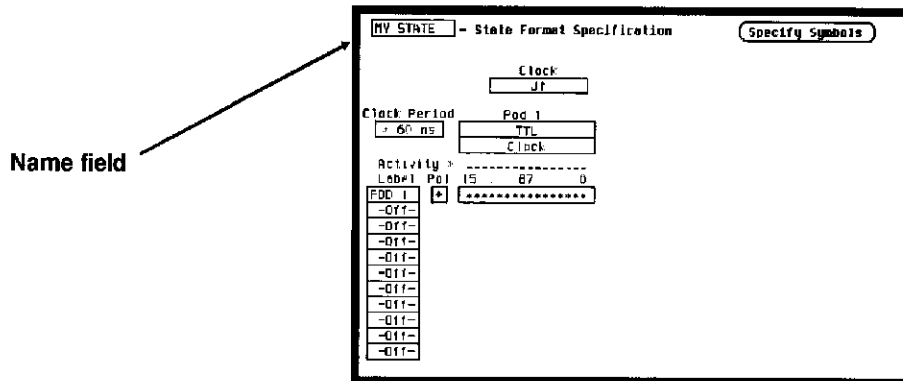

- From the pop-up that appears, select the name of the other analyzer or scope. The Format/Channel menu now appears for the new analyzer or scope.

If you want to move to the other menu types within the same machine, just press one of the other MENU keys defined below.

TRACE/TRIG

When you press the TRACE/TRIG key, you will have the following main menus available:

- Scope Trigger menu, if the scope is on.
- State Trace Specification menu, if the state analyzer is on.
- Timing race Specification menu, if the timing analyzer is on.

DISPLAY

When you press the DISPLAY key, you will have the following main menus available:

- Scope Waveforms menu, if the scope is on.
- State Listing menu, if the state analyzer is on.
- Timing Waveforms menu, if the timing analyzer is on.

When you are in any of the Waveforms or Listing menus, and you select the name field, you will notice an additional field called the **Mixed Mode** field.

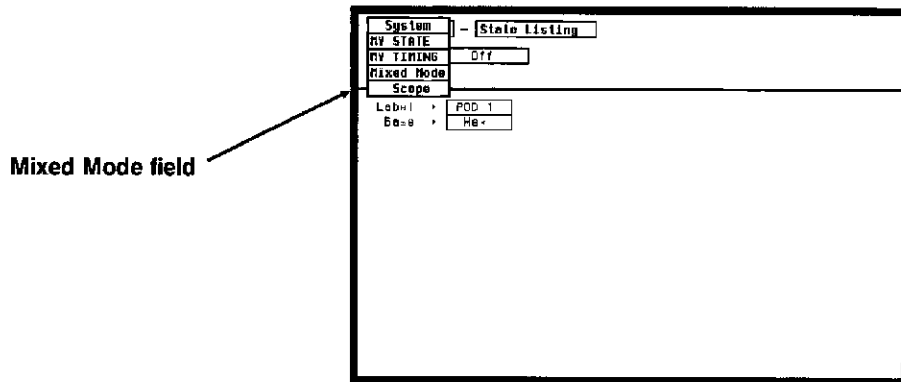

The **Mixed Mode** field as shown above, is only available from the Waveforms or Listing menus. That is, because it is like an optional display menu. When the **Mixed Mode** field is selected, a combined display is returned. The use of the Mixed Mode display is shown in detail in Chapters 21, 26 and 27 of the *HP 1652B/HP 1653B Front-Panel Operation Reference* manual.

Returning to the System Configuration Menu

If at any time you think you are lost, or just want to get back to the System Configuration menu, follow the procedure below.

1. Press either the **FORMAT/CHAN**, **TRACE/TRIG**, or **DISPLAY MENU** key. The menu that appears, will have a field in the upper left corner.
2. Select the field in the **upper left corner**. A pop-up appears that lists all machines which are turned on. The machine names are either the labels which you have assigned, or the default names of **MACHINE 1**, **MACHINE 2**, **SCOPE** and **Mixed Mode**.
3. Place the cursor over the **System** field and press the **SELECT** key. You will be returned to the System Configuration menu.

Summary

In this chapter you learned how to get from the System Configuration menu into the main menus of the separate analyzer machines. From within the main menus, you were shown how to move between menus, then quickly get back out to the System Configuration menu.

As you configured the System Configuration menu, you were introduced to some common pop-up menus. As mentioned earlier, more information on pop-up menus will appear in the following chapters.

Chapters 4 through 6 are simulated measurement examples. These chapters will illustrate how the logic analyzer is configured and used to make typical measurements. If you are new to logic analysis, and need a little more practice with your new logic analyzer, try following along with these simulated measurement examples. If you are an experienced logic analyzer user, you can go to the *HP 1652B/HP 1653B Front-Panel Operation Reference* manual at this point.

Using the State Analyzer

Introduction

In this chapter you learn how to use the state analyzer by setting up the logic analyzer to simulate a simple state measurement. We give you the measurement results as actually measured by the logic analyzer, since you may not have the same circuit available.

The exercise in this chapter is organized in a task format. The tasks are in the same order you will most likely use them once you become experienced. The steps in this format are both numbered and lettered. The numbered steps state the step objective. The lettered steps explain how to accomplish each step objective. There is also an example of each menu after it has been properly set up.

How you use the steps depends on how much you remember from chapters 1 through 3. If you can set up each menu by just looking at the menu picture, go ahead and do so. If you need a reminder of what steps to perform, follow the numbered steps. If you still need more information about "how," use the lettered steps.

Problem Solving with the State Analyzer

In this example assume you have designed a microprocessor controlled circuit. You have completed the hardware, and the software designer has completed the software and programmed the ROM (read-only memory). When you turn your circuit on for the first time, your circuit doesn't work properly. You have checked the power supply voltages and the system clock and they are working properly.

Since the circuit has never worked before, you and the software engineer aren't sure if it is a hardware or software problem. You need to do some testing to find a solution.

What Am I Going to Measure?

You decide to start where the microprocessor starts when power is applied. We will describe a 68000 microprocessor; however, every processor has similar start-up routines.

When you power up a 68000 microprocessor, it is held in reset for a specific length of time before it starts doing anything to stabilize the power supplies. The time the microprocessor is held in reset ensures stable levels (states) on all the devices and buses in your circuit. When this reset period has ended, the 68000 performs a specific routine called "fetching the reset vector."

The first thing you check is the time the microprocessor is held in reset. You find the time is correct. The next thing to check is whether the microprocessor fetches the reset vector properly.

The steps of the 68000 reset vector fetch are:

1. Set the stack pointer to a location you specify, which is in ROM at address locations 0 and 2.
2. Find the first address location in memory where the microprocessor fetches its first instruction. This is also specified by you and stored in ROM at address locations 4 and 6.

What you decide to find out is:

1. What ROM address does the microprocessor look at for the location of the stack pointer, and what is the stack pointer location stored in ROM?
2. What ROM address does the microprocessor look at for the address where its first instruction is stored in ROM, and is the instruction correct?
3. Does the microprocessor then go to the address where its first instruction is stored?
4. Is the executable instruction stored in the first instruction location correct?

Your measurement, then, requires verification of the sequential addresses the microprocessor looks at, and of the data in ROM at these addresses. If the reset vector fetch is correct (in this example) you will see the following list of numbers in HEX (default base) when your measurement results are displayed.

```
+ 0000 000000 0000  
+ 0001 000002 04FC  
+ 0002 000004 0000  
+ 0003 000006 8048  
+ 0004 008048 3E7C
```

This list of numbers will be explained in detail later in this chapter in "The State Listing."

How Do I Configure the Logic Analyzer?

In order to make this state measurement, you must configure the logic analyzer as a state analyzer. By following these steps you will configure Analyzer 1 as the state analyzer.

If you are in the System Configuration menu you are in the right place to get started and you can start with step 2; otherwise, start with step 1.

1. Using the field in the upper left corner of the display, get the System Configuration menu on screen.
 - a. Place the cursor on the field in the upper left corner of the display and press SELECT.
 - b. Place the cursor on **System** and press SELECT.
2. In the System Configuration menu, change the Analyzer 1 type to **State**. If Analyzer 1 is already a state analyzer, go on to step 3.

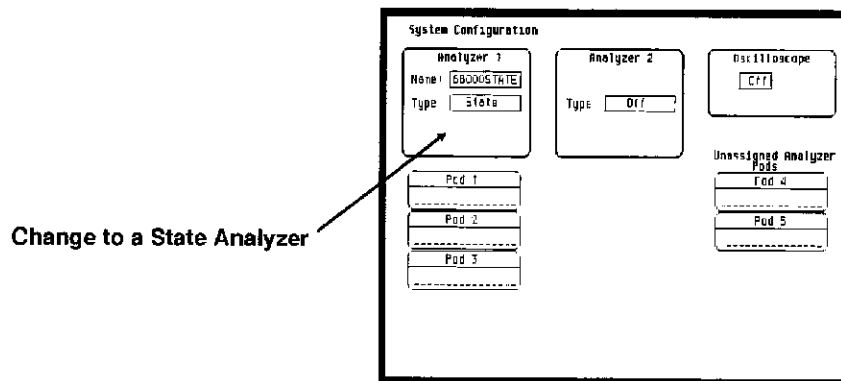

- a. Place the cursor on the **Type:** field and press SELECT.
- b. Place the cursor on **State** and press SELECT.

- 3 Name Analyzer 1 68000STATE (optional).
 - a. Place the cursor on the **Name:** field of Analyzer 1 and press **SELECT**.
 - b. With the Alpha Entry pop-up, change the name to 68000STATE.
4. Assign pods 1, 2, and 3 to the state analyzer.
 - a. Place the cursor on the **Pod 1** field and press **SELECT**.
 - b. In the Pod 1 pop-up, place the cursor on **Analyzer 1** and press **SELECT**.
 - c. Repeat steps *a* and *b* for pods 2 and 3.

Connecting the Probes

At this point, if you had a target system with a 68000 microprocessor, you would connect the logic analyzer to your system. Since you will be assigning labels ADDR and DATA, you hook the probes to your system accordingly.

- Pod 1 probes 0 through 15 to the data bus lines D0 through D15.
- Pod 2 probes 0 through 15 to the address bus lines A0 through A15.
- Pod 3 probes 0 through 7 to the address bus lines A16 through A23.
- Pod 1, CLK (J clock) to the address strobe (LAS).

Activity Indicators When the logic analyzer is connected and your target system is running, you will see **Activity Indicators** in the Pod 1, 2, and 3 fields of the System Configuration menu. This indicates which signal lines are transitioning.

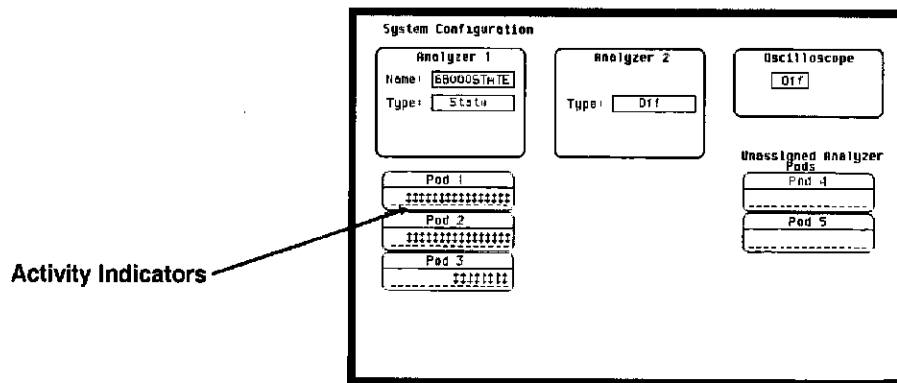

Configuring the State Analyzer

Now that you have configured the system, you are ready to configure the state analyzer. You will be:

- Creating two names (labels) for the input signals
- Assigning the channels connected to the input signals
- Specifying the State (J) clock
- Specifying a trigger condition

1. Display the State Format Specification menu.

a. Press the **FORMAT** key on the front panel.

2. Name two labels, one ADDR and one DATA.

SB00CSTATE - State Format Specification				Specify Symbols		
Clock J1						
Clock Period	Pod 0		Pod 1		Pod 2	
60 ns	TTL Clock		TTL Clock		TTL Clock	
Activity	Label	Pin	15	07	0	0
	ADDR	+	*****	*****	*****	*****
	DATA	+	*****	*****	*****	*****
	-Off-					
	-Off-					
	-Off-					
	-Off-					
	-Off-					
	-Off-					
	-Off-					
	-Off-					
	-Off-					
	-Off-					

a. Place the cursor on the top field in the label column and press **SELECT**.

b. Place the cursor on **Modify label** and press **SELECT**.

- c. With the Alpha Entry pop-up, change the name of the label to ADDR.
 - d. Name the second label DATA by repeating steps *a* through *c*.
 3. Assign Pod 1 bits 0 through 15 to the label DATA.
 - a. Place the cursor on the bit assignment field below Pod 1 and to the right of DATA and press SELECT.
 - b. Any combination of bits may already be assigned to this pod; however, you will want all 16 bits assigned to the DATA label. The easiest way to assign is to press the CLEAR ENTRY key to un-assign any assigned bits before you start
 - c. Place the cursor on the period under the 15 in the bit assignment pop-up and press SELECT. This will place an asterisk in the pop-up for bit 15, indicating Pod 1 bit 15 is now assigned to the DATA label. Repeat this procedure until all 16 bits have an asterisk under each bit number. Place the cursor on **Done** and press SELECT to close the pop-up
 - d. Repeat step *c* for Pod 2 and the ADDR label to assign all 16 bits.
 - e. Repeat step *c* except you will assign the lower eight bits (0 - 7) of Pod 3 to the ADDR label.

Specifying the J Clock

If you remember from "What's a State Analyzer" in *Feeling Comfortable With Logic Analyzers*, the state analyzer samples the data under the control of an external clock, which is "synchronous" with your circuit under test. Therefore, you must specify which clock probe you will use for your measurement. In this exercise, you will use the J clock, which is accessible through pod 1.

1. Select the State Format Specification menu by pressing the **FORMAT** key.
2. Set the J Clock to sample on a negative-going edge.

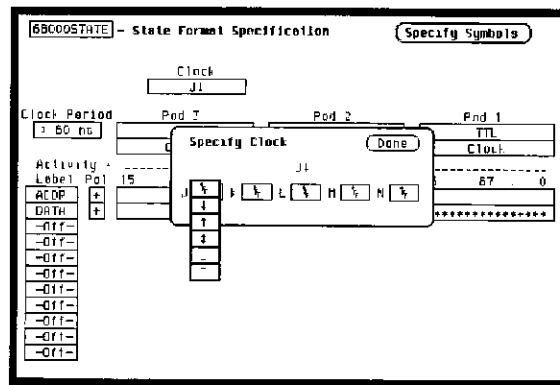

- a. Place the cursor on the **CLOCK** field and press **SELECT**.
- b. Place the cursor on the box just to the right of **J** in the pop-up (labeled **OFF**) and press **SELECT**.
- c. Place the cursor on ↓ and press **SELECT**.
- d. Place the cursor on **Done** and press **SELECT**.

Specifying a Trigger Condition

To capture the data and place the data of interest in the center of the display of the State Listing menu, you need to tell the state analyzer when to trigger. Since the first event of interest is address 0000, you need to tell the state analyzer to trigger when it detects address 0000 on the address bus.

1. Select the State Trace Specification menu by pressing the TRACE key.
2. Set the trigger so that the state analyzer triggers on address 0000. If the **Trigger on** option is not already "a" perform steps *a* through *d*. If the option is "a" skip to step *e*.

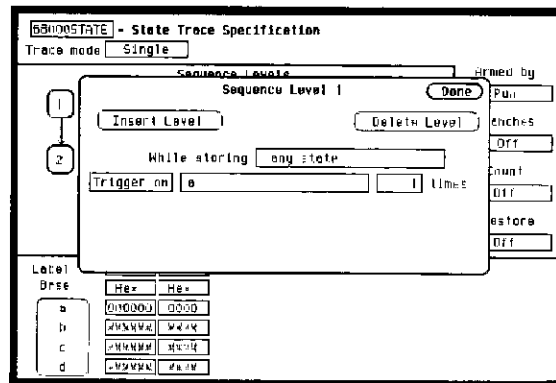

- a. Place the cursor on the 1 in the Sequence Levels field of the menu and press SELECT.
- b. Place the cursor on the field to the right of the **Trigger on** field and press SELECT. Another pop-up appears showing you a list of "trigger on" options. Options *a* through *h* are qualifiers. You can assign them a pattern for the trigger specification.

- c. Place the cursor on the "a" option and press SELECT.
- d. Place the cursor on Done in the Sequence Levels pop-up and press SELECT.
- e. Place the cursor on the field to the right of the "a" under the label ADDR and press SELECT.
- f. With the keypad, press 0 (zero) until there are all zeros in the Specify Pattern: pop-up and then press SELECT.

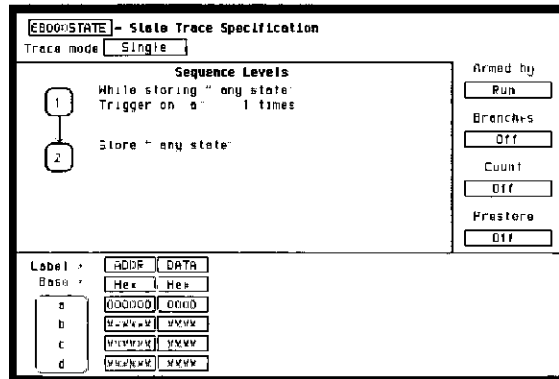

Your trigger specification now states: "While storing anystate trigger on "a" once and then store any state "

When the state analyzer is connected to your circuit and is acquiring data, it continuously stores until it sees 0000 on the address bus, then it will store anystate until the analyzer memory is filled.

Acquiring the Data

Since you want to capture the data when the microprocessor sends address 0000 on the bus after power-up, you press the RUN key to arm the state analyzer and then force a reset of your circuit. When the reset cycle ends, the microprocessor should send address 0000 trigger the state analyzer and switch the display to the State Listing menu.

We'll assume this is what happens in this example, since the odds that the microprocessor won't send address 0000 are very low.

Label	ADDR	DATA
Base	Hex	Hex
-0007	00B8C4	4E75
-0006	00B8C6	61E6
-0005	0004F0	0000
-0004	0004F2	88E8
-0003	00B8CB	B03C
-0002	00B8CH	06FF
-0001	00B8CC	6730
0000	000000	0000
0001	000002	04FC
0002	000004	0000
0003	000006	004B
0004	000008	2E7C
0005	00000A	0000
0006	00000C	04FC
0007	00000E	61D8
0008	000010	6100

Reset Vector Fetch Routine

The State Listing

The state listing displays three columns of numbers as shown:

State Locations

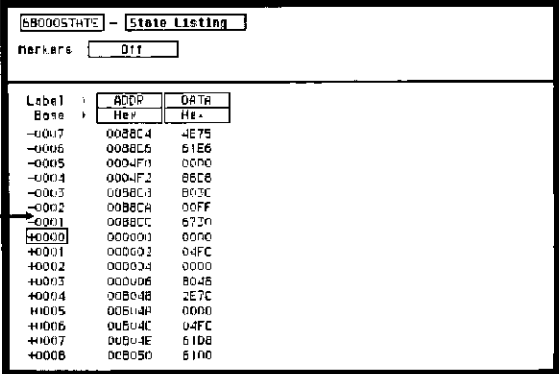

Label	ADDR	DATA
Base	Hex	Hex
-0007	008BC4	4E78
-0006	008BC5	51E6
-0005	0004F1	0000
-0004	0004F2	85C8
-0003	008BC3	807C
-0002	008BCA	00FF
-0001	008BCC	6730
+0000	000000	0000
+0001	000002	04FC
+0002	000004	0000
+0003	000006	8048
+0004	00B048	2E7C
+0005	00B148	0000
+0006	00B04C	04FC
+0007	00B04E	61D8
+0008	00B050	61D0

The first column of numbers are the state line number locations as they relate to the trigger point. The trigger state is always on line + 0000 in the vertical center of the list area. The negative numbers indicate states occurring before the trigger and the positive numbers indicate states occurring after the trigger.

The second column of numbers are the states (listed in HEX) the state analyzer sees on the address bus. This column is labeled ADDR.

The third column of numbers are the states (listed in HEX) the state analyzer sees on the data bus. This column is labeled DATA.

Finding the Answer

Your answer is now found in the listing of states + 0000 through + 0004.

The 68000 always reads address locations 0, 2, 4, and 6 to find the stack pointer location and memory location for the instruction it fetches after power-up. The 68000 uses two words for each of the locations that it is looking for, a high word and a low word. When the software designer programs the ROM, he must put the stack pointer location at address locations 0 and 2. 0 is the high word location and 2 is the low word location. Similarly, the high word of the instruction fetch location must be in address location 4 and the low word in location 6.

Since the software design calls for the reset vector to set the stack pointer to 04FC and read memory address location 8048 for its first instruction fetch, you are interested in what is on both the address bus and the data bus in states 0 through 3.

The state listing below lists the codes reset vector search, in states 0 through 3 and the correct first microprocessor instruction in state 4.

```
+ 0000 000000 0000
+ 0001 000002 04FC
+ 0002 000004 0000
+ 0003 000006 8048
+ 0004 008048 3E7C
```

You see that states 0 and 1 do contain address locations 0 and 2 under the ADDR label, indicating the microprocessor did look at the correct locations for the stack pointer data. You also see that the data contained in these ROM locations are 0000 and 04FC, which are correct.

You then look at states 2 and 3. You see that the next two address locations are 4 and 6, which is correct, and the data found at these locations is 0000 and 8048, which is also correct.

So far you have verified that the microprocessor has correctly performed the reset vector search. The next thing you must verify is whether the microprocessor addresses the correct location in ROM that it was instructed to address in state 4 and whether the data is correct in this ROM location. From the listing on your machine, you see that the address in state 4 is 008048, which is correct, but the instruction found in this location is 2E7C, which is not correct. You have found your problem: incorrect data stored in ROM for the microprocessor's first instruction.

- + 0000 000000 0000 (high word of stack pointer location)
- + 0001 000002 04FC (low word of stack pointer location)
- + 0002 000004 0000 (high word of instruction fetch location)
- + 0003 000006 8048 (low word of instruction fetch location)
- + 0004 008048 2E7C (first microprocessor instruction)

Label	Address	ADDP	DATA
Base	Hex	Hex	Hex
-0007	00BEC4	4E7E	
-0006	00BEC6	61E6	
-0005	0004F0	0000	
-0004	0004F2	88C8	
-0003	00BEC8	863C	
-0002	00BECA	00FF	
-0001	00BECC	6720	
+0000	000000	0000	
+0001	000002	04FC	
+0002	000004	0000	
+0003	008048	8048	
+0004	00804B	2E7C	← Incorrect Data
+0005	00804E	0000	
+0006	00804C	04FC	
+0007	00804E	61D8	
+0008	008050	6100	

Summary

You have just learned how to make a simple state measurement with the HP 1652B Logic Analyzer. You have:

- specified a state analyzer
- learned which probes to connect
- assigned pods 1, 2, and 3
- assigned labels
- assigned bits
- specified the J clock
- specified a trigger condition
- acquired the data
- interpreted the state listing

You have seen how easy it is to use the state analyzer to capture the data on the address and data buses. You can use this same technique to capture and display related data on the microprocessor status control, and various strobe lines. You are not limited to using this technique on microprocessors. You can use this technique any time you need to capture data on multiple lines and need to sample the data relative to a system clock

Chapter 21 of the *HP 1652B/HP 1653B Front-Panel Operation Reference* manual shows you how to use the logic analyzer as an interactive timing and state analyzer. You will see a simple measurement that shows you both timing waveforms and state listings and how they are correlated.

If you have an HP 1653B, you do not have enough channels to simultaneously capture all the data for a 68000. But, since you probably aren't working with 16-bit microprocessors, this example is still valuable because it shows you how to make the same kind of measurement on an eight-bit microprocessor.

Using the Timing Analyzer

Introduction

In this chapter you will learn how to use the timing analyzer by setting up the logic analyzer to simulate a simple measurement. We give you the measurement results as actually measured by the logic analyzer, since you may not have the same circuit available.

The exercise in this chapter is organized in a task format. The tasks are ordered in the same way you will most likely use them once you become an experienced user. The steps in this format are both numbered and lettered. The numbered steps state the step objective. The lettered steps explain how to accomplish each step objective. There is also an example of each menu after it has been properly set up.

How you use the steps depends on how much you remember from chapters 1 through 3. If you can set up each menu by just looking at the menu picture, go ahead and do so. If you need a reminder of what steps you need to perform, follow the numbered steps. If you still need more information about "how," use the lettered steps.

Problem Solving with the Timing Analyzer

In this exercise, assume you are designing a dynamic RAM memory (DRAM) controller and you must verify the timing of the row address strobe (RAS) and the column address strobe (CAS). You are using a 4116 dynamic RAM and the data book specifies that the minimum time from when LRAS is asserted (goes low) to when LCAS is no longer asserted (goes high) is 250 ns. You could use an oscilloscope but since the timing analyzer will do just fine when you don't need voltage parametrics you decide to go ahead and use the logic analyzer.

What Am I Going to Measure?

After configuring the logic analyzer and hooking it up to your circuit under test, you will be measuring the time (x) from when the RAS goes low to when the CAS goes high, as shown below.

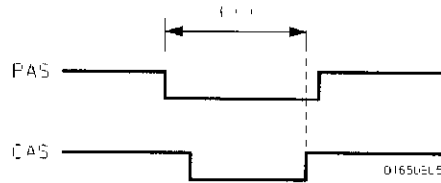

How Do I Configure the Logic Analyzer?

In order to make this timing measurement, you must configure the logic analyzer as a timing analyzer. By following these steps you will configure Analyzer 1 as the timing analyzer.

If you are in the System Configuration menu you are in the right place to get started and you can start with step 2; otherwise, start with step 1.

1. Using the field in the upper left corner of the display, get the System Configuration menu on screen.
 - a. Place the cursor on the field in the upper left corner of the display and press SELECT.
 - b. Place the cursor on **System** and press SELECT.
2. In the System Configuration menu, change Analyzer 1 type to **Timing**. If analyzer 1 is already a timing analyzer, go on to step 3.
 - a. Place the cursor on the **Type:** field and press SELECT.
 - b. Place the cursor on **Timing** and press SELECT.

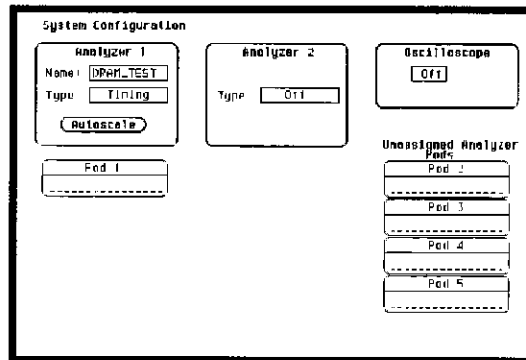

3. Name Analyzer 1 "DRAM TEST" (optional)

a. Place the cursor on the **Name:** field of Analyzer 1 and press SELECT.

b. With the Alpha Entry pop-up, change the name to "DRAM TEST"

4. Assign pod 1 to the timing analyzer.

a. Place the cursor on the **Pod 1** field and press SELECT.

b. In the Pod 1 pop-up, place the cursor on **Analyzer 1** and press SELECT.

Connecting the Probes

At this point, if you had a target system with a 4116 DRAM memory IC, you would connect the logic analyzer to your system.

Since you will be assigning Pod 1 bit 0 to the RAS label, you hook Pod 1 bit 0 to the memory IC pin connected to the RAS signal. You hook Pod 1 bit 1 to the IC pin connected to the CAS signal.

Activity Indicators

When the logic analyzer is connected and your target system is running, you will see activity indicators, as shown below, at the right-most end (least significant bits) of the Pod 1 field in the System Configuration menu. This indicates the RAS and CAS signals are transitioning.

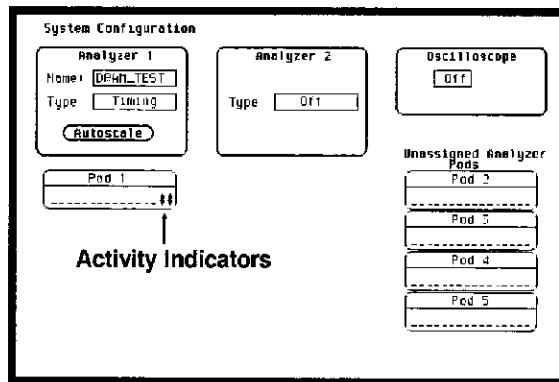

Configuring the Timing Analyzer

Now that you have configured the system, you are ready to configure the timing analyzer. You will be:

- Creating two names (labels) for the input signals
- Assigning the channels connected to the input signals
- Specifying a trigger condition

1. Display the Timing Format Specification menu.

a. Press the **FORMAT** key on the front panel.

2. Name two labels, one RAS and one CAS.

a. Place the cursor on the top field in the label column and press **SELECT**.

b. Place the cursor on **Modify** label and press **SELECT**.

c. With the Alpha Entry pop-up, change the name of the label to **RAS**.

d. Name the second label **CAS** by repeating steps *a* through *c*.

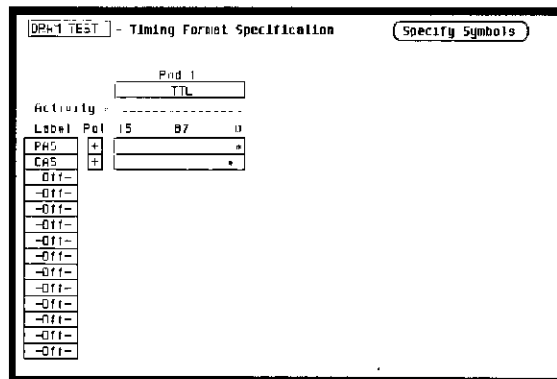

3. Assign the channels connected to the input signals (Pod 1 bits 0 and 1) to the labels RAS and CAS respectively.

- a. Place the cursor on the bit assignment field below Pod 1 and to the right of RAS and press SELECT.
- b. Any combination of bits may be assigned to this pod; however, you will want only bit 0 assigned to the RAS label. The easiest way to assign bits is to press the CLEAR ENTRY key to un-assign any assigned bits before you start.
- c. Place the cursor on the period under the 0 in the bit assignment pop-up and press SELECT . This will place an asterisk in the pop-up for bit 0 indicating Pod 1 bit 0 is now assigned to the RAS label. Place cursor on **Done** and press SELECT to close the pop-up
- d. Assign Pod 1 bit 1 to the CAS label by moving the cursor to bit 1 and pressing SELECT.

Specifying a Trigger Condition

To capture the data and then place the data of interest in the center of the display of the Timing Waveforms menu, you need to tell the logic analyzer when to trigger. Since the first event of interest is when the L_{RAS} is asserted (negative-going edge of RAS), you need to tell the logic analyzer to trigger on a negative-going edge of the RAS signal.

1. Select the Timing Trace menu by pressing the **TRACE** key.
2. Set the trigger so that the logic analyzer triggers on the negative-going edge of the RAS.
 - a. Place the cursor on the **Then find Edge** field under the label RAS, then press **SELECT**.
 - b. Place the cursor on the "." (period) in the pop-up and press **SELECT** once. Pressing **SELECT** once in this pop-up changes a period to ↓ which indicates a negative-going edge.
 - c. Place the cursor on **Done** and press **SELECT**. The pop-up closes and a \$ will be located in this field. The \$ indicates an edge has been specified even though it can't be shown in the HEX base.

The screenshot shows a dialog box titled "CRAM TEST - Timing Trace Specification". It contains several fields and buttons for configuring a timing trace. The "Trace mode" is set to "Single" and "Triggered by" is set to "Pun". The "Acquisition mode" is set to "Transitional". Under the "Label" field, "RAS" is selected. The "Base" is set to "Hex". The "Find" field shows a period "." and a downward arrow "↓". The "Pattern" field shows "y" and "x". The "present for" field is set to "30 ns". The "Then find" field shows a "\$" symbol.

Acquiring the Data

Now that you have configured and connected the logic analyzer, you acquire the data for your measurement by pressing the RUN key. The logic analyzer will look for a negative edge on the RAS signal and trigger if it sees one. When it triggers, the display switches to the Timing Waveforms menu.

The RAS label shows you the RAS signal and the CAS label shows you the CAS signal. Notice the RAS signal goes low at or near the center of the waveform display area (horizontal center).

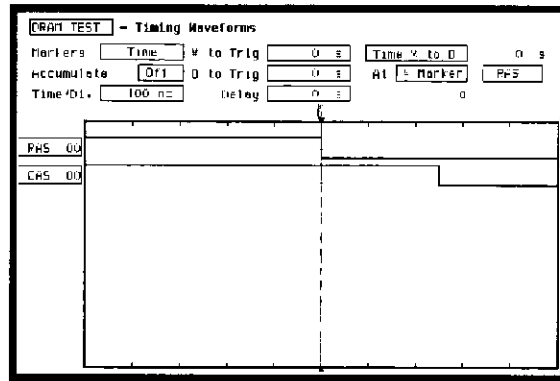

The Timing Waveforms Menu

The Timing Waveforms menu differs from the other menus you have used so far in this exercise. Besides displaying the acquired data, it has menu fields that you use to change the way the acquired data is displayed and fields that give you timing answers. Before you can use this menu to find answers, you need to know some of the special symbols and their functions. The symbols are:

- The X and O
- The ▼
- The vertical dotted line

The X and O The X and O are markers you use to find your answer. You place them on the points of interest on your waveforms, and the logic analyzer displays the time between the markers. The X and O markers will be in the center of the display when X to trig (ger) and O to trig (ger) are both 0.000 s (see example below).

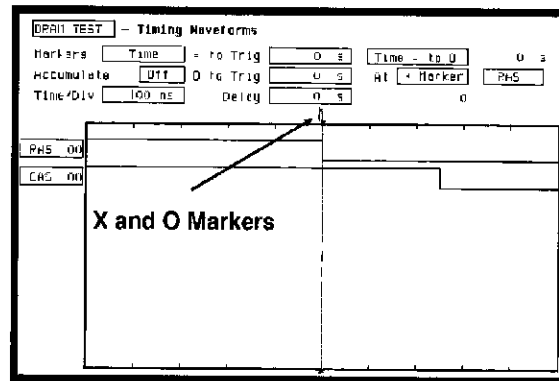

The ▼ The ▼ (inverted triangle) indicates the trace point. Remember, trace point = trigger + delay. Since delay in this example is 0.000 s, you will see the negative-going edge of the RAS signal at center screen under the ▼.

The Vertical Dotted Line The vertical dotted line indicates the trigger point you specified in the Timing Trace Specification menu. The vertical dotted line is at center screen under the inverted triangle and is superimposed on the negative-going edge of the RAS signal.

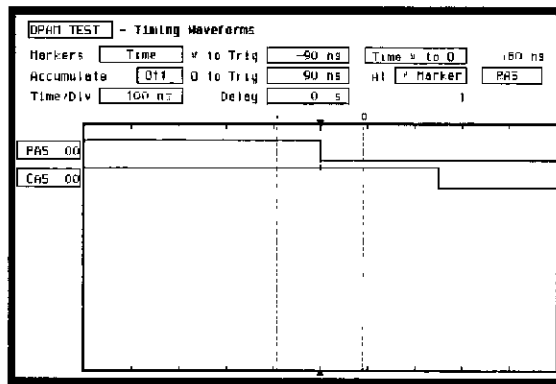

Configuring the Display

Now that you have acquired the RAS and CAS waveforms, you need to configure the Timing Waveforms menu for best resolution and to obtain your answer.

Display Resolution

You get the best resolution by changing the Time/Div to a value that displays one negative-going edge of both the RAS and CAS waveforms. Set the Time/Div by following these steps.



1. Place the cursor on Time/Div and press SELECT . The Time/Div pop-up appears, showing you the current setting.
2. While the pop-up is present, rotate the KNOB until your waveform shows you only one negative-going edge of the RAS waveform and one positive-going edge of the CAS waveform (see above). In this example 200 ns is best.

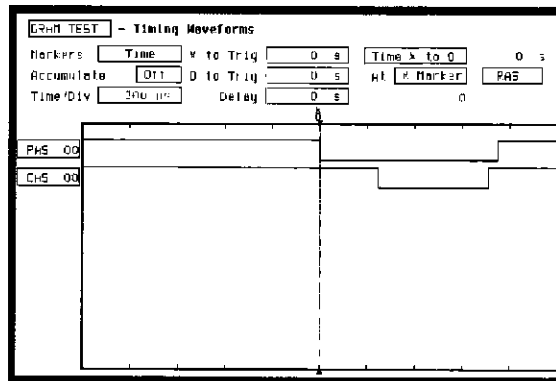

Making the Measurement

What you want to know is how much time elapses between the time RAS goes low and the time CAS goes high again. You will use the X and O markers to quickly find the answer. Remember, you specified the negative-going edge of the RAS to be your trigger point; therefore, the X marker should be on this edge if X to Trig = 0. If not, follow steps 1 and 2.

1. Place the cursor on the **X to Trig** field and press SELECT . A pop-up will appear showing you the current time from the X marker to the trigger; however, you don't need to worry about this number now.
2. Rotate the KNOB to place the X marker on the negative-going edge of the RAS waveform and press SELECT . The pop-up closes and displays X to Trig = 0.000 s.
3. Place the cursor on **O to Trig** and press SELECT . Repeat step 2 except place the O marker on the positive-going edge of the CAS waveform and press SELECT. The pop-up closes and displays O to Trig = 710 ns.

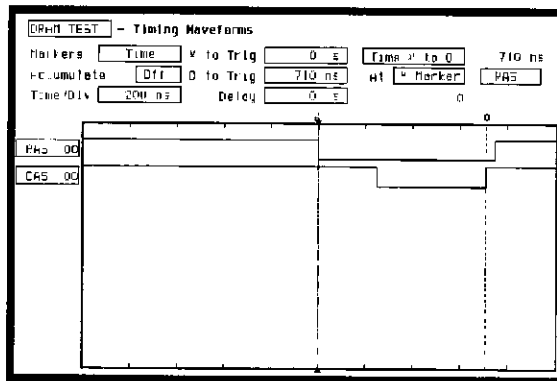

Finding the Answer

Your answer could be calculated by adding the X to Trig and O to Trig times, but you don't need to bother. The logic analyzer has already calculated this answer and displays it in the **Time X to O** field.

This example indicates the time is 710 ns. Since the data book specifies a minimum of 250 ns, it appears your DRAM controller circuit is designed properly.

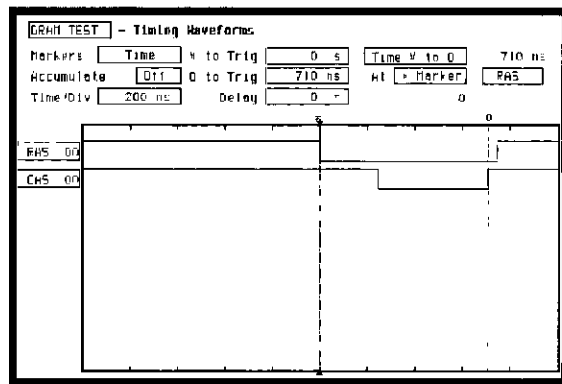

Summary

You have just learned how to make a simple timing measurement with the HP 1652B/1653B logic analyzer. You have learned to do the following:

- Specified a timing analyzer.
- Assigned pod 1.
- Assigned bits.
- Assigned labels.
- Specified a trigger condition.
- Learned which probes to connect.
- Acquired the data.
- Configured the display.
- Set the Time/Div for best resolution.
- Positioned the markers for the measurement answer.

You have seen how easy it is to use the timing analyzer to make timing measurements that you could have made with a scope. You can use the timing analyzer for any timing measurement that doesn't require voltage parametrics or doesn't go beyond the accuracy of the timing analyzer.

Using the Oscilloscope

Introduction

This chapter uses a simple example to get you familiar with using the oscilloscope. We will be starting from the beginning with this exercise, so it's not necessary to have completed chapters 4 and 5.

As you follow through the menus setups in this exercise, you will use the Probe Compensation signal from the rear panel as the signal source for measurement. If you think you can complete this exercise by just following the illustrated menus, do so. If you need additional help, follow the numbered steps.

Getting to the Scope Menu

From the default System Configuration menu shown below, the scope should already be turned on. If the scope is not turned on, turn on the scope and turn off the analyzers. Now, get to the scope Channel menu.

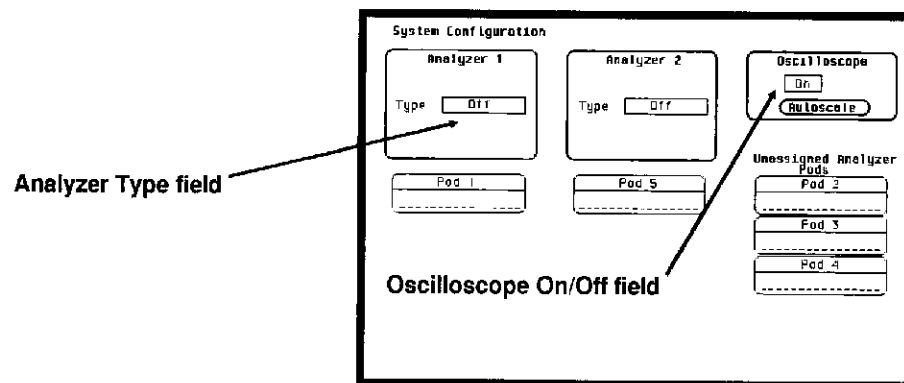

1. Toggle the Oscilloscope **On/Off** field to **On**.
2. Select the analyzer **Type:** field, then turn all analyzers **Off**.
3. Press the **FORMAT/CHAN** menu key.

Setting Up for the Measurement

Setting up for the measurement consists of two parts. The first part, is the actual hook-up to the "system under test." This first part is where you connect the scope probes and set up any external test equipment. The second part of the setup is the input attenuation and impedance setting of your oscilloscope. For the example in this chapter, we are using the Probe Compensation Signal from the rear panel.

Connect two BNC cables and a BNC tee as shown below. An optional extra long BNC cable can be used to produce a delay on one of the channels.

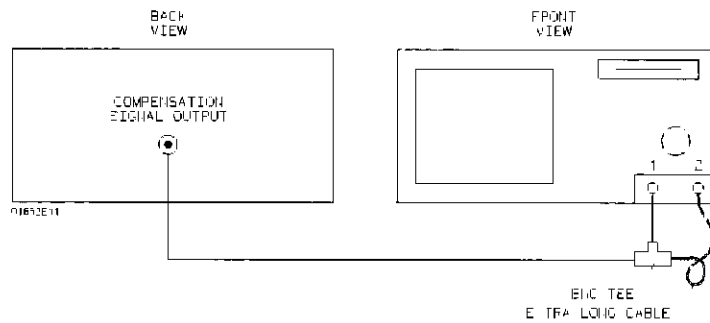

Note 

BNC cable length is not important, but cable impedance must be 50 Ω impedance.

Set the **probe attenuation** field and the input **Impedance** field as shown below in the scope Channel menu.

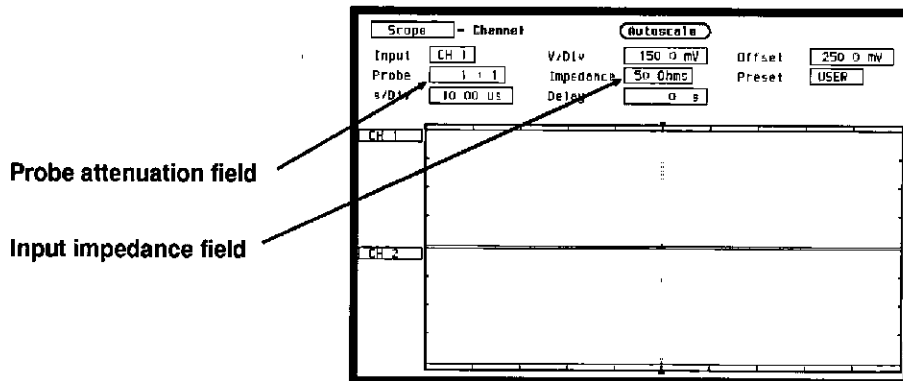

Probe attenuation field
Input impedance field

1. Select the **Probe** field. Using the knob or keypad, set the attenuation to **1:1**.
2. Select the **Impedance** field. Toggle to **50 Ohms**.

Making the Measurement

By selecting the **Autoscale** field, the measurement will automatically be scaled, positioned, and is displayed on the scope's Waveforms menu as shown below.

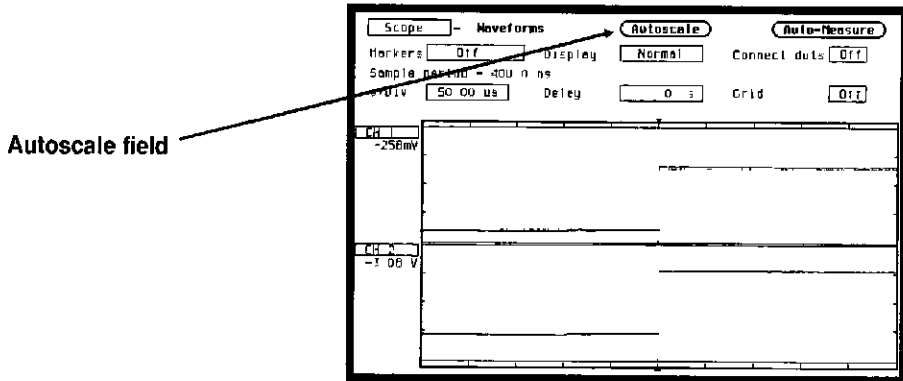

Autoscale field

1. Select the **Autoscale** field, then select **Continue** from the pop-up.

Displaying the Results

Now that you have the measurement results on screen, you can modify the Waveforms display to view the signals any way you want. The figure below shows just some of the many effects that occur when you change the Waveforms menu configuration.

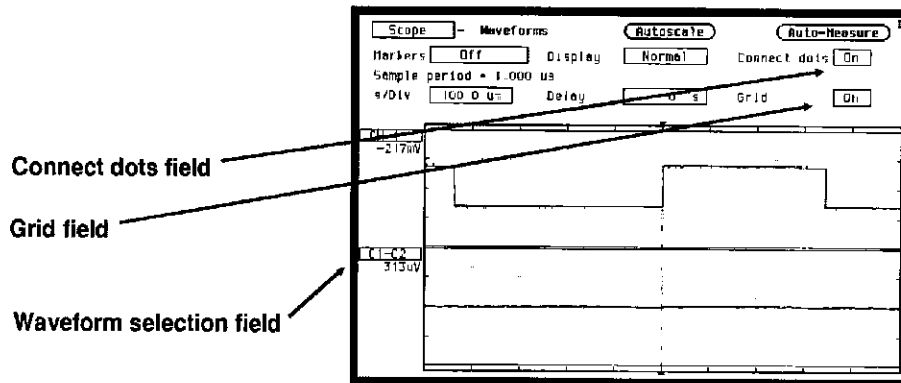

1. Select the **Connect dots** field. Toggle to **On**.
2. Select the **Grid** field. Toggle to **On**.
3. Select the **s/Div** field. Using the knob or keypad, set the seconds per division to **100 μ s**.
4. Select the **CH 2** waveform selection field, then select the **Modify waveform** field from the pop-up. Select the **C1-C2** field from the pop-up.
5. Press the **RUN** key (not necessary when Run mode set to Repetitive).

Automatic Measurement Readouts

When the **Auto-Measure** field is selected, you get a parametric readout of nine parameters as shown in the figure below.

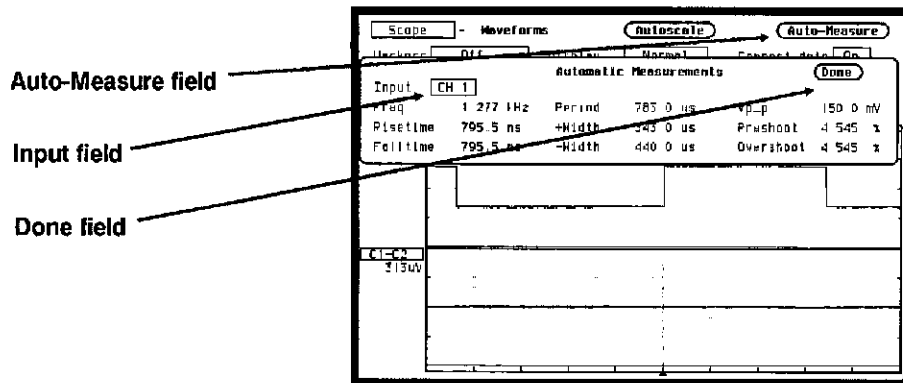

1. From the scope Waveforms menu, select the **Auto-Measure** field.
2. To get a readout for the other channel, move the cursor to the **Input** field, then press the **SELECT** key. The input will then automatically toggle to the other channel.
3. To exit the Auto-Measure pop-up, select **Done**.

Using the Markers

Your oscilloscope has the ability to set markers (reference points) either manually or automatically. This may be important if your measurement requires that you know the exact time between different points on the waveform or from the point your scope triggered on the waveform.

In this exercise we set only the Time markers. For a complete description of the markers function, refer to the *HP 1652B\HP 1653B Front-Panel Operation Reference* manual.

From the scope Waveforms menu, select the **Markers** field. A pop-up appears that lists the different kinds of marker measurements available. As mention before, you will make just a Time marker measurement for now.

Set the Time markers menu to match the figure below.

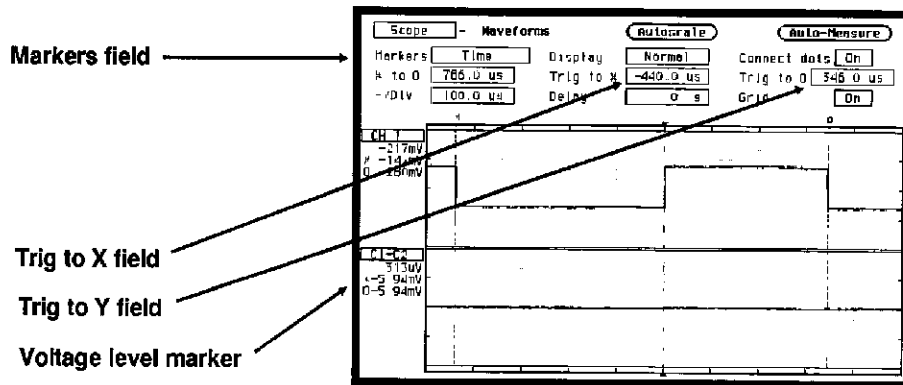

1. From the scope Waveforms menu select the **Markers** field. Select the **Time** field from the pop-up.
2. To set the X-marker, select the **Trig to X** field. Using the knob, move the marker to the left (negative time from trigger point) until the dashed line is aligned with the falling edge of the pulse.
3. To set the Y-marker, select the **Trig to Y** field. Using the knob, move the marker to the right (positive time from trigger point) until the dashed line is aligned with the falling edge of the next pulse.

Now that you have set the X and O markers on these edges of the waveform, the following time relevant information is available:

- Time between markers is displayed in the **X to O** field.
- Time between markers and trigger point is displayed in the **Trig to X** field and the **Trig to O** field.
- The voltage level of the waveform at the point the markers were placed is displayed under the channel label.

Summary

After finishing the exercises in chapters 4 through 6, you should now be familiar with your new logic analyzer. If you want more detailed information on how your logic analyzer operates, refer to the *HP 1652B/HP 1653B Front-Panel Operation Reference Manual*.

If you have a printer and would like to make hardcopy prints of configurations in any of the previous exercises, refer to Appendix B "Making Hardcopy Prints."

What's Next?

Now that you are familiar with the logic analyzer, you may want to try some of the basic measurements discussed in this book on your target system. Refer to the documentation for your microprocessor.

If you are comfortable with the basic measurements that you can perform with the HP 1652B and HP 1653B Logic Analyzers, you are ready for the *HP 1652B/HP 1653B Front-Panel Operation Reference*. This reference manual explains all the capabilities of both logic analyzers and their operation from the front panel. The *HP 1652B/HP 1653B Programming Reference* manual tells you how to operate both logic analyzers from a controller via the RS-232C or HP-IB interface.

A

Logic Analyzer Turn-on Check List

This appendix summarizes the steps you take to turn on the HP 1652B and HP 1653B logic analyzers. The details of the turn-on procedures are in Chapter 1 of this Guide.

1. Check the rear-panel line voltage indicator for the proper setting. Change the setting if necessary.
2. Make sure you have the proper 3-wire grounded AC power cable.
3. Make sure the rear-panel line switch is **Off**.
4. Connect the power cable to the rear-panel line connector and a properly grounded power receptacle.
5. Make sure the yellow shipping disk is removed from the disk drive.
6. Insert the operating system disk in the disk drive.
7. Turn the logic analyzer on with the rear-panel line switch.

When the logic analyzer completes its self-tests, it then loads the operating system from the disk. When the operating system has been completely loaded, the **System Configuration** menu will be displayed.

Making Hardcopy Prints

Introduction

The HP 1652B and HP 1653B Logic Analyzers allow you to print the configurations, waveforms, and listings. Whenever your printer is connected to your logic analyzer and you instruct it to do so, it will print what is currently displayed on screen.

This chapter shows you how to set up the logic analyzer's HP-IB and RS-232C interfaces and how to instruct the logic analyzer to make a print. If you have a Hewlett-Packard ThinkJet, QuietJet, or LaserJet series printer with the RS-232C interface, the RS-232C interface is already set up for you.

If you have another kind of printer, refer to your printer manual for its interface requirements and change your logic analyzer's interface configuration as instructed.

Hooking Up Your Printer

If your printer is already connected to the logic analyzer, skip to "Setting RS-232C for HP Printers" or "Setting HP-IB for HP Printers." If not, hooking up your printer is just a matter of having the correct HP-IB or RS-232C interface cable. Refer to the *Front Panel Reference Manual* you received with your logic analyzer.

Setting RS-232C for HP Printers

All you have to do to set the interface for any of the previously listed Hewlett-Packard series printers with the RS-232C interface is to set the printer type in the **External I/O Port Configuration** submenu.

To set the printer type, follow these steps:

1. Display the I/O menu by pressing the I/O key.
2. Place the cursor on **I/O Port Configuration** and press **SELECT**.

You will see the following submenu:

The screenshot shows a terminal window titled "External I/O Port Configuration" with a "Done" button in the top right corner. The window is divided into several sections:

- Printer connected to:** RS-232-C
- Controller connected to:** HP-IB
- RS-232-C Configuration:**
 - Protocol: NON+OFF
 - Stop Bits: 1
 - Parity: NONE
 - Baud rate: 2400
 - Data Bits: 8
- HP-IB Configuration:**
 - HP-IB Address: 7
- Printer Information:**
 - Printer: LaserJet
 - Paper width: 8.5"

3. If the **Printer connected to** field displays **RS-232C** skip to step 4. Otherwise, place the cursor in the **Printer connected to HP-IB** field and press **SELECT**. The **Printer connected to** switches from **HP-IB** to **RS-232C**.
4. Place the cursor on the printer series type and press **SELECT**.
5. Place the cursor on **Done** and press **SELECT**. The logic analyzer will display the menu that was displayed when you selected the I/O menu.

Setting RS-232C for Your Non-HP Printer

The following attributes of the RS-232C interface must be set to the correct configuration for your printer:

- Protocol
- number of stop bits
- parity type
- Baud rate
- paper width

You can set all of these attributes for your printer by following this procedure:

1. Press the **I/O** key to display the I/O menu.
2. Place the cursor on **I/O Port Configuration** and press **SELECT**.
3. Place the cursor on the attribute and press **SELECT**.
4. When the pop-up is open, place the cursor on the option your printer requires and press **SELECT**. The pop-up closes, placing your selection in the box. Repeat this step for all attributes that you need to change.
5. Place the cursor on **Done** and press **SELECT**. The logic analyzer will display the menu that was displayed when you selected the I/O menu.

Setting Hp_IB for HP Printers

The HP 1652B/HP 1653B interfaces directly with HP PCL printers supporting the printer command language. These printers must also support HP-IB and "Listen Always." Printers currently available from Hewlett-Packard with these features include:

- HP 2225A ThinkJet
- HP 2227B QuietJet
- HP 3630A option 002 PaintJet



The printer must be in "Listen Always" mode when HP-IB is the printer interface. The HP 1652B/HP 1653B HP-IB port does not respond to service requests (SRQ) when controlling a printer. The SRQ enable setting for the HP-IB printer has no effect on the HP 1652B/HP 1653B operation.

For HP-IB printers, the **Printer connected to** field must be set to **HP-IB** in the I/O Port Configuration menu. You access this menu by first pressing the I/O key, then moving the cursor to the **I/O Port Configuration** field and pressing **SELECT**.

Print All The **Print all** option prints not only what is displayed on screen, but also what is off screen at the time you initiate the printout. In the **Print All** mode, the printout will be made in the text mode with only one exception: a timing waveform display will be printed in the graphics mode because it has no off-screen data.

Use this option when you want to print all the data in menus like:

- Timing and State Format Specifications
- State Trace Specifications
- State Listing

What Happens during a Printout?

When you press select to start the printout, the I/O menu pop-up disappears and an advisory **PRINT in progress** appears in the top center of the display. While the data is transferred to the printer, the logic analyzer's keyboard deactivates. When the logic analyzer has completed the data transfer to the printer, the advisory disappears and the keyboard reactivates.

Don't worry! The **Print in progress** advisory won't appear in your printout.

Summary

Now that you have configured the RS-232C or HP-IB interface for your printer, you can make hardcopy printouts of anything that the logic analyzer displays. This is a valuable feature when you need to keep records of configurations and measurements.

Starting the Printout

When you are ready to print, you will need to know whether there is more data than is displayed on screen. In cases where data is off screen (i.e., format specifications with all pods assigned to a single analyzer), you need to decide whether you want all the data or just the data is on screen.

If you want just what is on screen, start the printout with the **Print Screen** option. If you want all the data, use the **Print All** option. Both options are in the **I/O** menu.

Once you decide which option to use, start the printout by placing the cursor on the print option (screen or all) and pressing **SELECT**.

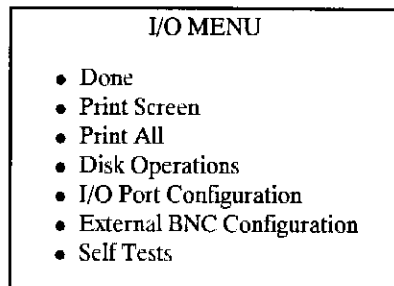

Print Screen The **Print Screen** option prints only what is displayed on screen at the time you initiate the printout. In the **Print Screen** mode, the printer uses its graphics capabilities so the printout will look just like the logic analyzer screen with only one exception: the cursor will not print.